

FIBERGLASS BASIN EXTENSION

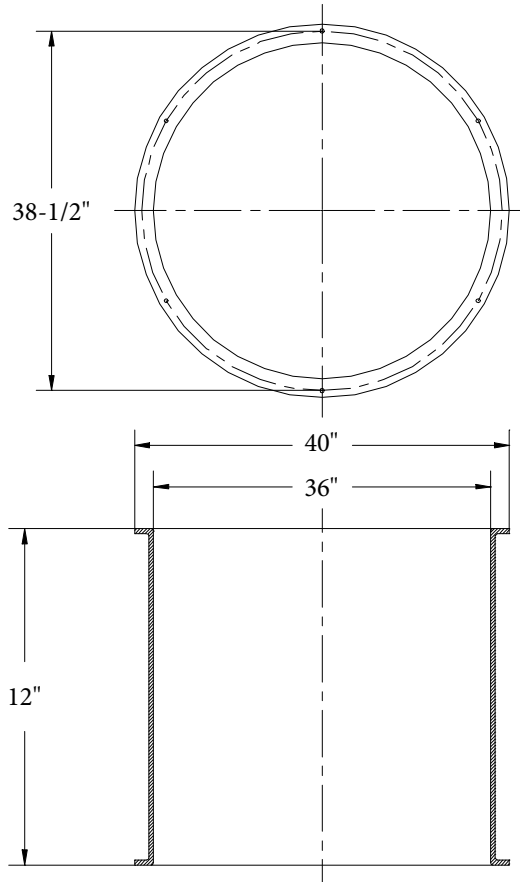

PART NO.	Ⓐ EXTENSION INSIDE DIA.	Ⓑ EXTENSION OUTSIDE DIA.	Ⓒ EXTENSION DEPTH	Ⓓ BOLT CIRCLE DIA.
FG36x012-EX	36	40	12	38-1/2

ALL DIMENSIONS IN INCHES



Fiberglass Basin Extension Reference:	Scale: None Drawn By: <i>RM</i> App'd By: . Date: 03/02/04	This print is and contains confidential proprietary information owned exclusively by TOPP INDUSTRIES, INC. It is furnished on a strictly confidential basis. This restriction includes, but is not limited to the condition that this print will not only be used as a record or to identify or inspect parts or for other information purposes and will not be used to manufacture or procure the manufacture of the items shown in this print by any other source than TOPP INDUSTRIES, INC.
Highway 25 North P.O. Box 480 Rochester, IN 46975 Phone: 800/354-4534 Fax: 574/223-6106	Supersedes Prints Prior To: 03/02/04	Reference No: 17509

Revisions	
Ⓐ	First Released.