

## 30ACi



### 30ACi

1. 600 va Inverter, PN: TW20313
2. Battery Box, PN: EP0----300
3. WC33M, PN: M5235033MN
4. Ion Switch, PN: IN-006-010-10PA
5. Ion Pipe-Mount Bracket, PN: IN-SPB-1
6. Battery Leads with Anderson Connector

## 35ACi



### 35ACi

1. 800 va Inverter, PN: TW20315
2. Battery Box, PN: EP0----300
3. BA33M, PN: HP20180
4. Ion Switch, PN: IN-006-010-10PA
5. Ion Pipe-Mount Bracket, PN: IN-SPB-1
6. Battery Leads with Anderson Connector

## 30ACi Deluxe



### 30ACi Deluxe

1. 600 va Inverter, PN: TW20313
2. Battery Box, PN: EP0----300
3. (2) WC33M, PN: M5235033MN
4. Ion Genesis, PN: ING2-10-1B
5. Battery Leads with Anderson Connector

## 35ACi Deluxe



### 35ACi Deluxe

1. 800 va Inverter, PN: TW20315
2. Battery Box, PN: EP0----300
3. (2) BA33M, PN: HP20180
4. Ion Genesis, PN: ING2-10-1B
5. Battery Leads with Anderson Connector

## INTRODUCTION

Reasonable care and safe methods should be practiced. Check local codes and requirements before installation. This manual contains important information for the safe use of this product. Read this manual completely before using this product and refer to it often for continued safe product use.

**Note:** This manual covers the installation of the inverter, regardless of what pump, switch or controller combination is included in the system you purchased. For more detailed installation information and troubleshooting regarding the pump, switch or controller, please refer to their individual manuals. Although the inverters for the 30ACi and 35ACi systems are slightly different, they both operate on 12 volts with identical connections.

DO NOT THROW AWAY OR LOSE THIS MANUAL. Keep it in a safe place so that you may refer to it when needed.

## IMPORTANT SAFETY INSTRUCTIONS

Before proceeding further, kindly go through the safety instructions carefully.

Always disconnect the unit from the receptacle power source and battery before handling or making any adjustments to the system.

### Battery Backup Warning:



**WARNING:** Risk of electrical shock this unit has not been investigated for use in outdoor areas.



**WARNING:** Risk of electrical shock. Connect only to a properly grounded, three pronged grounding type receptacle. Under any circumstances, do not remove the grounding prong from the power cord.



**WARNING:** Do not smoke, use spark able electrical devices or open flame when working on this unit!



**WARNING:** Do not install unit in locations classified as hazardous per N.E.C., ANSI/NFPA 70 - 1999.

## FAILURE TO HEED ABOVE CAUTIONS COULD RESULT IN INJURY OR DEATH.



**WARNING:** These systems are designed to operate **only one pump at a time**, the one(s) supplied with the unit. Using anything other than the pump supplied with the system will cause damage to the unit and void the warranty.

### General Precautions:

Before using the inverter, read all instructions and caution markings on the inverter, the batteries & all appropriate sections of this instruction manual.



**WARNING:** Do not expose the inverter to any type of chemicals. The inverter is designed for interior use only.



**WARNING:** Do not disassemble the inverter; take it to a qualified service center when service or repair is required. Opening by unqualified personnel can lead to electrical shock or fire hazard and void the warranty.

To reduce risk of electric shock, disconnect all wiring before cleaning.



**WARNING:** Avoid exposing the inverter or batteries to any type of explosive gases (in the vicinity, as batteries generate explosive gases during normal operation). Provide proper ventilation. The battery enclosures should be designed to prevent accumulation and concentration by hydrogen gas in "pockets" at the top of the compartment. Vent the battery compartment from the highest point. A sloped lid can also be used to direct the flow to the vent opening location. To reduce the risk of the battery explosion, follow all the instructions of the battery supplier or any equipment you intend to use in the vicinity of batteries.



**WARNING:** Use the correct insulated tools to make AC/DC wiring connections.



**WARNING:** Do not install this inverter on or near flammable materials (plywood, chemicals, gas online etc.)

#### Personal Precautions



**CAUTION:** Someone should be within the range of your voice to come to your aid when you work near batteries.



**CAUTION:** Have plenty of fresh water and soap nearby in the event that battery acid contact skin, clothing or eyes.



**CAUTION:** Wear complete eye and clothing protection.



**CAUTION:** Avoid touching eyes while working near batteries. Wash your hands when done.



**CAUTION:** If battery acid comes in contact with skin or clothing, wash immediately with soap and water.

### KNOWING YOUR INVERTER

In its most basic form, an inverter transforms Direct Current (DC) to Alternating Current (AC). The battery acts as a reserve to ensure continuous supply of power whenever mains supply from utility power is not available. The inverter is used to charge the battery when normal utility power is available and converts the battery's DC to AC voltage to run the pump when utility power is lost.

### BATTERY SAFETY

A battery can present a risk of severe burn and injury from high short circuit current. The following precautions should be observed when working on batteries.

1. Do not dispose of battery in a fire. The battery may explode.
2. Do not open or mutilate the battery. Released electrolyte is harmful to the skin and eyes. It may be toxic.
3. The electrolyte is a dilute sulfuric acid that is harmful to the skin and eyes. It is electrically conductive and corrosive. The following

procedures should be observed:

- a. If electrolyte contacts the skin, wash it off immediately.
  - b. If electrolyte contacts the eyes, flush thoroughly and immediately with water. Seek medical attention.
  - c. Spilled electrolyte should be washed down with a suitable acid neutralizing agent. A common practice is to use a solution of approximately one pound (500 grams) bicarbonate of soda to approximately one gallon (4 liters) of water. The bicarbonate of soda solution should be added until the evidence of reaction (foaming) has ceased. The resulting liquid should be flushed with water and the area dried.
4. Do not reverse the battery connections, as it will blow the battery fuse. A power cord has been provided to connect the inverter to incoming AC wall outlet.

### BATTERY REQUIREMENTS

Your unit operates on 12 VDC battery power when in the power fail mode. A UL recognized deep cycle marine battery should be used. There are two principal types of batteries: starting and deep cycle. There are several different types of battery constitutions including liquid lead acid, nickel iron, nickel cadmium, alkaline and maintenance free. Batteries are sealed or vented.

#### Starting Batteries

Starting batteries are designed for high cranking power but not deep cycling. Do not use them with your inverter. They do not affect the inverter, but they will simply not last long in a deep cycle application. They use lot of thin plates to maximize the surface area of the battery. This allows very high starting current but less run time when the battery is cycled.

#### Deep Cycle Batteries

Deep cycle batteries are best suited for use with the inverter. They are designed to have the majority of their capacity used before recharge. Available in many sizes and types, be sure to use at least a 100AH battery.

## REPLACING BATTERY

Wear full eye protection and protective clothing.

When replacing the battery/batteries, use the same type and size battery/batteries. **See Page 2, Battery Requirements.**



**DANGER:** The electrolyte is a dilute sulfuric acid that is harmful to the skin and eyes. It is electrically conductive and corrosive. The following procedures should be observed:

- Do not lay tools or metal objects on top of the batteries
- Use tools with insulated handles

### When Inverter is Operating on AC Power

1. Unplug the unit from the wall.
2. Follow the Installation Instructions of this manual, starting with step 8 and working back to step 1.
3. Remove and safely dispose of old batteries.
4. Install new battery, starting with Step 1 of the Installation Instructions.

### When Inverter is Operating on DC Power

1. Follow Steps 1 – 4 above.
2. Push and hold the Power button on the front of the inverter for 3 – 5 seconds.

## BATTERY MAINTENANCE

If you are using AGM maintenance free batteries, you do not need to perform any maintenance to your batteries. For all other batteries, refer to the manufacturer recommended battery maintenance section of the battery being used.

Maintenance or replacement of batteries should be performed or supervised by personnel knowledgeable of batteries and the required precautions.

## TOOLS NEEDED

A pipe wrench, insulated pliers, insulated adjustable wrench, and insulated screwdriver will be needed.

## INSTALLATION INSTRUCTIONS

Remove all packaging from the box. It should include: an inverter, battery box, pig tail with Anderson connector, inverter power cord and pump with Ion® switch.

Find a suitable place to set the unit. Keep in mind that the unit should be placed in an area where water and moisture will not splash or drip on the unit, the fan inlet on the sides of the enclosure will not be obstructed and where a properly grounded three prong dedicated receptacle is within reach of the power cord.

- Remove watches, rings, or other metal objects.
  - Use tools with insulated handles
  - Do not lay tools or metal parts on top of batteries
1. Install the 12 volt deep cycle marine battery into the plastic battery box. Make sure that the MCB (main circuit breaker) on the back of your inverter is in the OFF position.
  2. Connect the black negative (-) wire of the pig tail to the negative (-) terminal of the 12 volt battery.
  3. Connect the red positive (+) wire of the pig tail to the positive (+) terminal of the 12 volt battery.
  4. Lay wires over the side of the battery box so the Anderson connector is on the outside of the battery box. Install the plastic cover on the battery box so that the red and black wires come out of the battery box and set the inverter on top of the battery box cover.
  5. Plug the Anderson connector from the inverter into the Anderson connector from the battery, insuring that the wire colors match on both sides.
  6. Install the sump pump in the sump pit and place the sump cover back on the sump pit so that

the pump switch cord and pump power cord reach the inverter.

7. Plug the switch cord into the back of the inverter and the pump cord into the switch cord. **See Figure A on this page.**
8. Connect the inverter power cord to 120 AC power and turn the MCB switch to ON position. Your system is now ready.

### 9. Powering Up

To charge your battery, make sure the MCB is in the ON position. The LCD display will come on and show the condition of the battery. If the battery is fully charged, the battery display will have all bars lit and show 100%. If the battery is charging, the battery display will cycle the bars from bottom to top and show the percentage of charge. This shows that the charger is working properly in AC mode. Any AC load powered by the inverter should also work at this point, since a portion of the AC power is passed through the inverter to power the load.

The Power button on the front of the inverter is to be used in the event that the battery needs to be replaced while the unit is in DC mode, **See Page 3, Replacing Battery.** If setting up the inverter when AC power is available, the Power button is automatically on. If the button is held in for 3 - 5 seconds while in AC mode, the display will go blank and the inverter will be off. The inverter can be turned back on by holding in the Power button again for 3 - 5 seconds or unplugging the inverter from the wall outlet for 10 seconds and plugging it back in.

**Note:** The range of the switch is the distance between the On and Off levels. The Off level is at the bracket mounting screw of the switch. From this point, measure up to find the On level, **see Figure B on this page.**

The Ion® switch does not operate like a standard pressure switch. There are no contacts to wear out, so when pressure is applied, there will not be a click.

### 10. Testing

While the inverter is on AC power, fill the basin up with a bucket or garden hose to verify that the pump turns on at the correct level. Once the pump turns on, let it pump the basin out

until it shuts off. Repeat three times.

Unplug the power cord from the wall outlet. The inverter will beep with the battery bars cycling from top to bottom. The battery percentage will slowly start to drop. The inverter is now in DC mode, taking the battery power and using it to power the load uninterrupted. Fill the basin again, as described above, to verify the pump's operation in DC mode. **Make sure you plug the inverter back into the wall outlet.**

**The above steps will complete a function test of the inverter. If all areas pass, the inverter is ready for use. If any areas fail, see the troubleshooting table.**

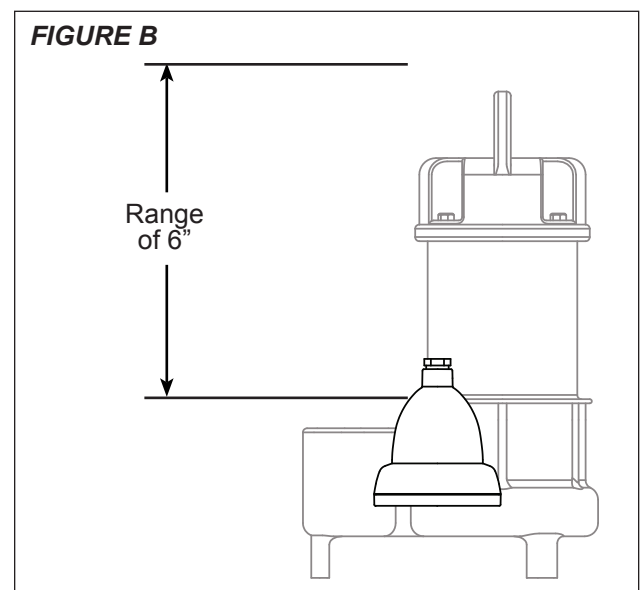
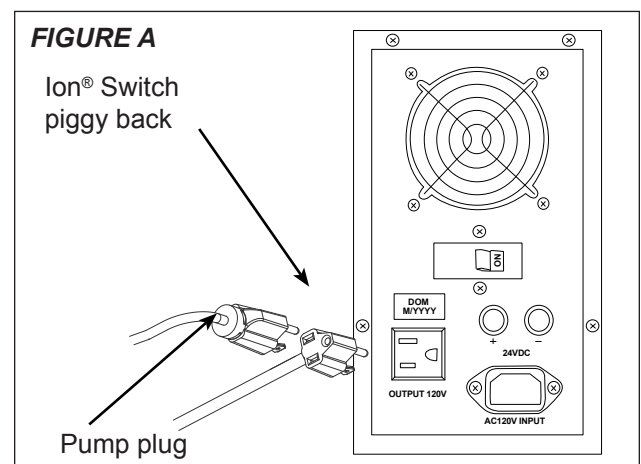



**BACK PANEL**

The inverter has two battery leads coming out from the back of the inverter, with an Anderson connector on the end, a MCB (main circuit breaker), pump output socket (120 volt) and a power cord to connect with AC power (120 volt). The Anderson connector on the inverter leads gets connected to the Anderson connector on the Pig Tail coming from the battery.

**30ACi / 30ACi Deluxe**

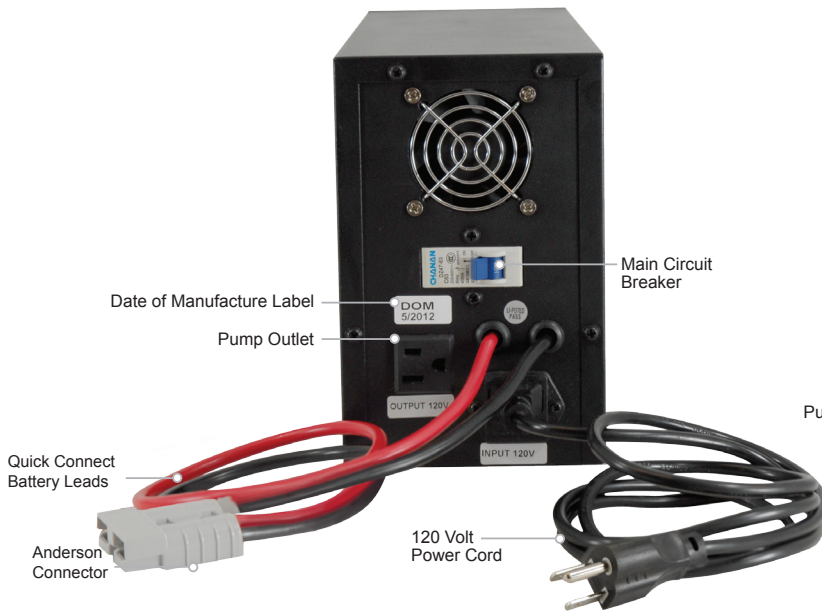

**35ACi / 35ACi Deluxe**



**FRONT PANEL**

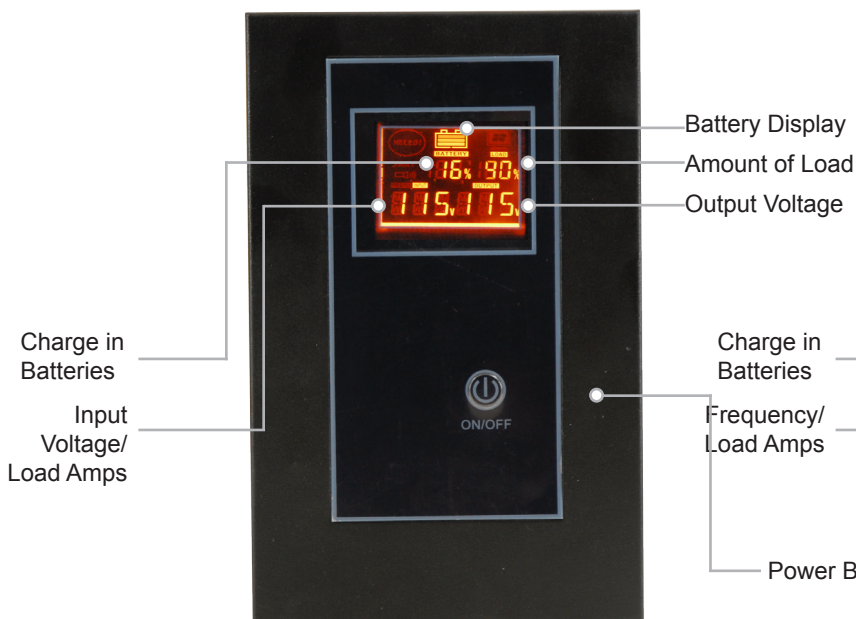

**AC MODE**

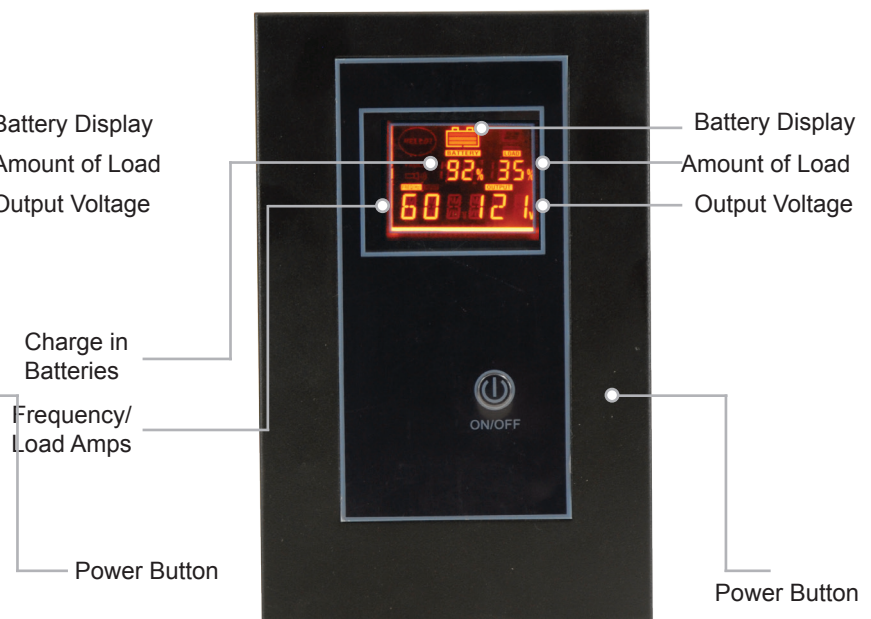

**DC MODE**

**TECHNICAL SPECIFICATIONS**

**30ACi / 30ACi Deluxe**

**Inverter Specifications**

Mains A.C. Lower Voltage Limit	90 VAC $\pm$ 5V
Output Voltage with Full Load	110 - 120V $\pm$ 10 V
Maximum Output Power	4.0 FLA
Battery Lower Voltage Limit	10.5 VOC $\pm$ 0.2 V
<b>Output Frequency</b> Main Output Frequency	Same as Input
Battery Charger Boost Voltage	13.7 $\pm$ 0.2 V
Overload	130% $\pm$ 3% (With Auto Reset Function)

**Pump Specifications**

Model	Motor		
	HP	Amp	Voltage
WC33	1/3	4.0	115

**35ACi / 35ACi Deluxe**

**Inverter Specifications**

Mains A.C. Lower Voltage Limit	90 VAC $\pm$ 5 V
Output Voltage with Full Load	110 - 120V $\pm$ 10 V
Maximum Output Power	5.5 FLA
Battery Lower Voltage Limit	10.5 VOC $\pm$ 0.2 V
<b>Output Frequency Main Output Frequency</b>	Same as Input
Battery Charger Boost Voltage	13.7 $\pm$ 0.2 V
Overload	130% $\pm$ 3% (With Auto Reset Function)

**Pump Specifications**

Model	Motor		
	HP	Amp	Voltage
BA33	1/3	4.5	115

**30ACi / 30ACi Deluxe System Performance Curve**

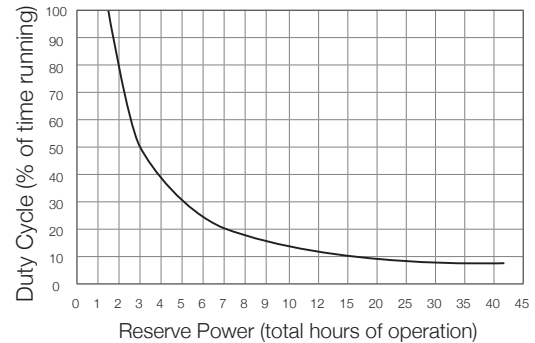

**30ACi / 30ACi Deluxe Pump Performance Curve**

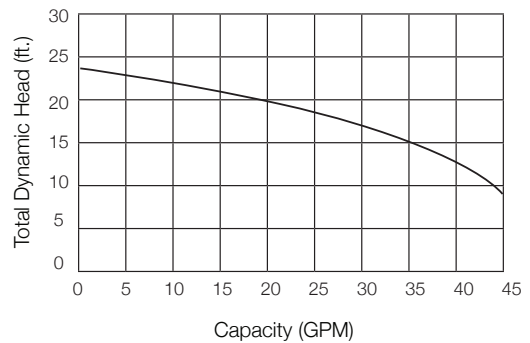

**35ACi / 35ACi Deluxe System Performance Curve**

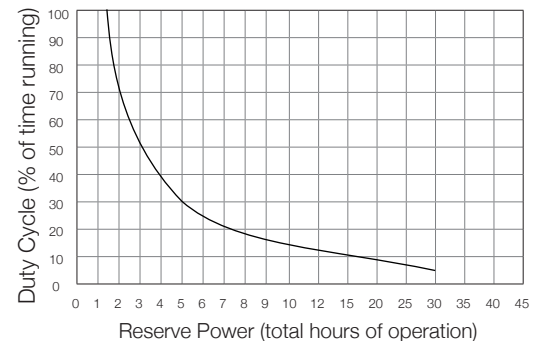

**35ACi / 35ACi Deluxe Pump Performance Curve**

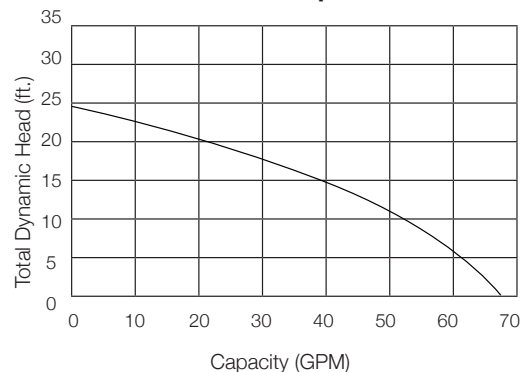

## **TROUBLESHOOTING**

### **1. Inverter Mode but No Power**

- a. Check display to see if a low battery condition is present. Remove all loads, unplug the AC power cord for 10 sec. and plug it back in. Allow the battery to charge when the AC Power resumes before running the Inverter on battery again.
- b. Check display to see if fault condition is present.

### **2. Inverter Does Not Operate and No Message On Display**

- a. Push and hold Power button on front of the unit for 3 - 5 seconds.
- b. Check the battery connections and the mains connections.

### **3. Inverter Trips Frequently In DC Mode**

- a. Reduce the load and reset the inverter.
  - i. Inlet holes in pump base may be clogged. Remove pump and clean the openings.
  - ii. Pump impeller may be partially clogged with tar or paint, causing motor to run slow and overload. Remove pump and clean.
  - iii. Motor stator may be defective.

### **4. Pump Does Not Run In DC Mode**

- a. Possible low battery.
  - i. Check conditions of batteries and recharge.
- b. Possible loose or corroded battery connection.
  - i. Check and clean all connections.

### **5. AC Power Is Available but the Inverter Will Not Operate in AC Mode**

- a. Push and hold Power button on front of the unit for 3 - 5 seconds.

- b. Possible loose AC output connection.

- i. Check all AC output connections.
- ii. Check main 15 amp circuit breaker to the wall outlet.

### **6. Low Surge Power**

- a. Possible weak batteries or battery cables are too long.
  - i. Refer to cable and battery recommendation in this manual.

### **7. Inverter Overheats**

- a. Inverter is hot.
  - i. Reduce load and let the inverter cool down.

### **8. If Pump Does Not Run and Hums**

- a. Inverter circuit breaker is off.
- b. Water level in sump has not reached turn-on level.
- c. Pump cord is not making contact in receptacle.
- d. Ion switch may not be working properly.
  - i. Plug pump directly into wall outlet without the Ion plug. If pump runs, the Ion switch may need to be replaced.
- e. If all of the above are OK, then the motor could be malfunctioning.

### **9. Pump Runs but Does Not Deliver Water**

- a. Check valve is installed backwards. Arrow on valve should point in direction of flow.
- b. Discharge shut-off valve (if used) may be closed.
- c. Impeller or volute openings are fully or partially clogged. Remove pump and clean.
- d. Pump is air-locked. Start and stop several times by plugging and unplugging cord. Check for clogged vent hole in pump



case. Drill a 1/8 inch hole into PVC pipe approximately 4" above the pump discharge connection.

- e. Inlet holes in pump base are clogged. Remove pump and clean the openings.
- f. Vertical pumping distance is too high. Reduce distance or change the discharge fittings of the pump.

#### **10. Pump Runs and Pumps Out Sump but Does Not Stop**

- a. Unplug the pump/Ion plug from the inverter.
- b. Plug the pump back into the Ion plug and plug the Ion plug into a wall outlet.
  - i. If the pump does not turn on right away, and the water level is not at the On level, let the pump go through an On / Off cycle a few times to insure that the switch is functioning properly. The basin may need to be filled with a garden hose or bucket. Plug pump/Ion plug back into one outlet on the inverter and test again.
  - ii. If the pump turns on right away, and the water level is not at the On level, the switch may have to be replaced.

#### **11. Pump Runs but Only Delivers a Small Amount of Water**

- a. Pump may be air-locked. Start and stop several times by plugging and unplugging cord. Check for clogged vent hole in pump case. Drill a 1/8 inch hole into PVC pipe.
- b. Vertical pumping distance may be too high. Reduce distance or change the discharge fitting of the pump. Inlet holes in pump base are clogged. Remove pump and clean the strainer and openings.
- c. Impeller or volute openings may be fully or partially clogged. Remove pump and clean.
- d. Pump impeller is partially clogged with tar or paint, causing motor to run slow and overload. Remove pump and clean.

#### **12. Fuse Blows or Circuit Breaker Trips**

- a. Pump impeller may be partially clogged with tar or paint, causing motor to run slow and overload. Remove pump and clean.
- b. Motor stator may be defective.
- c. Fuse size or circuit breaker may be too small. Must be 15 amp.
- d. Impeller or volute opening may be fully or partially clogged. Remove pump and clean.

#### **13. Motor Runs for a Short Time Then Stops**

- a. Inlet holes in pump base may be clogged. Remove pump and clean the openings.
- b. Pump impeller may partially clogged with tar or paint, causing motor to run slow and overload. Remove pump and clean.
- c. Motor stator may be defective.

#### **14. Pump Does Not Turn On**

- a. Test the pump without the Ion switch.
  - i. Plug the pump directly into a wall outlet, without plugging it into the Ion plug.
  - ii. If pump still does not run, the pump may be defective.
  - iii. If the pump does run, continue to the next step.
- b. Test the switch with the pump.
  - i. Plug the pump into the Ion® switch and plugging the Ion switch plug into the wall.
  - ii. Push up on the sensing plate through the center hole on the underside of the switch. Note that, being an electronic switch, you will not hear a clicking sound.
  - iii. If the pump does not turn on, the switch may have to be replaced.
  - iv. If the pump does turn on, continue to the next step.

- c. Verify the range of the switch. Your system should have been supplied with a 6" range switch.
  - i. **See Page 5, Figure A** to verify that the On level is appropriate for your basin.
    - 1. If the On level is too high, contact the installer.

**WARRANTY IS VOID IF...**

1. Using an extension cord.
2. Any power cord has been cut or the grounding prongs removed or using an adapter fitting.
3. Inverter has been used in an outdoor application.
4. Batteries not meeting the above specifications have been used.
5. Inverter has been submerged in water.
6. Inverter has been tampered with in any manor not described in the above instructions.
7. Working on the inverter, pump or switch while plugged in.
8. Inverter has been disassembled by customer.
9. Inverter has been applied to products exceeding the maximum capacity of the inverter, i.e., a pump other than the one supplied with the unit or running more than one pump at the same time.
10. Inverter has been applied to the wrong voltage.
11. Removing motor housing, unscrewing impeller, or otherwise removing impeller seal of pump.
12. Running the pump continuously.
13. Pumping chemicals or corrosive liquids.
14. Pumping gasoline or other flammable liquids.
15. Any tags or labels have been removed from the inverter, pump or Ion™ Digital Level Control switch.



### 3 Year Residential Warranty

1. **Coverage and Term.** Metropolitan Industries, Inc. (“**Metropolitan**”) warrants to the original purchaser (the “**Buyer**”) of each StormPro/Sumpro product (the “**product**”), that any part thereof which proves to be defective in material or workmanship within three (3) years from date of manufacture, will be replaced at no charge with a new or remanufactured part, F.O.B. factory. Buyer shall be responsible for all freight charges and all costs of field labor or other charges incurred in the removal and/or reinstallation of any product, part or component thereof.
2. **Exclusions. THE WARRANTY IS SUBJECT TO THE FOLLOWING CONDITIONS AND EXCLUSIONS:**
  - (a) The Warranty excludes products or workmanship which becomes defective as a result of: (i) earthquake, fire, storms, the elements or any other acts of God; (ii) normal wear and tear from use; (iii) accident, misuse, abuse or neglect; (iv) modifications made by Buyer or any third party, other than **Metropolitan**; and (v) Buyer’s failure to properly install, maintain, service and/or operate the product under normal conditions and according to manufacturer’s instructions.
  - (b) **Metropolitan** shall not be responsible for, and the Warranty shall not cover, extended damage which occurs because of Buyer’s failure to notify **Metropolitan** promptly in writing of apparent defects.
  - (c) Any part or component designated as manufactured by anyone other than **Metropolitan** shall be covered only by the express warranty of the manufacturer thereof.
  - (d) The Warranty shall lapse upon Buyer’s failure to fully comply with the terms and conditions of its contract with **Metropolitan**, including Buyer’s failure to pay the purchase price for the product or any portion thereof. Buyer’s subsequent compliance with the terms and conditions of any such contract, will not cause the term of the Warranty to extend beyond the time period set forth above.
  - (e) No actions taken by **Metropolitan** to correct a defect in a product shall extend the Warranty beyond the period set forth above. **Metropolitan** shall not be obligated to remedy any defect, where otherwise required pursuant to the Warranty unless and until Buyer notifies **Metropolitan** in writing of the defect and then only if such notification is made prior to the expiration of the period set forth above.
3. **Process of Claims and Repairs.** **Metropolitan** agrees that if the product or any part or component thereof shall fail to conform to the terms of this Warranty, **Metropolitan** shall replace such nonconforming product, part or component at the original point of delivery and furnish instruction for its disposition. Any transportation charges involved in such disposition and all costs of field labor or other charges incurred in the removal and/or reinstallation of any product, part or component thereof shall be the responsibility of Buyer.
4. **Limitation on Liability.** Notwithstanding any provision to the contrary, **Metropolitan’s** entire liability under this Warranty shall not in the aggregate exceed, and Buyer’s exclusive and sole remedies are, to the extent permitted by law, shall be to secure replacement of the defective product. **UNDER NO CIRCUMSTANCES SHALL METROPOLITAN BE LIABLE UNDER THE WARRANTY FOR ANY INDIRECT, PUNITIVE, SPECIAL, EXEMPLARY, CONSEQUENTIAL OR INCIDENTAL DAMAGES (INCLUDING LOST PROFITS, REVENUE, USE OR ECONOMIC ADVANTAGE).**
5. **Express Waiver of Any Other Warranties.** **THE EXPRESS WARRANTY SET FORTH IN THIS WRITTEN WARRANTY IS THE ONLY WARRANTY MADE BY METROPOLITAN, OR ANY OTHER PARTY, IN CONNECTION WITH ANY PRODUCT PURCHASED FROM METROPOLITAN. NEITHER METROPOLITAN, NOR ANY OTHER PARTY, MAKES ANY OTHER EXPRESS OR IMPLIED WARRANTY WHICH IS NOT SET FORTH HEREIN, AND METROPOLITAN HEREBY DISCLAIMS AND BUYER HEREBY WAIVES ALL IMPLIED WARRANTIES, INCLUDING THE IMPLIED WARRANTY OF MERCHANTABILITY AND THE IMPLIED WARRANTY OF FITNESS FOR A PARTICULAR PURPOSE.**
6. **Not Transferable.** The Warranty may not be transferred and shall be void on the sale or other transfer of the product.
7. **Products and Warranty Subject to Change.** **Metropolitan** reserves the right to make revisions to its products and their specifications, and to revise this Warranty and related information without notice.